

Work happily



V1.3

naggura'swop

naggura.com

# Nos produits

 Podo



Swop P3 Pro Podo est un fauteuil de podologie à 3 moteurs avec une stabilité optimale et un châssis ultra-ferme.

Bois, Métal ou PMMA



# Collections

Nordic  
MÉTAL

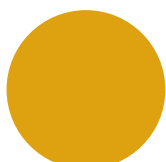

Yellow

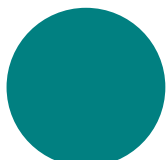

Blue

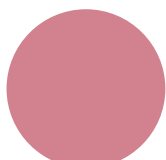

Pink

Foll  
MÉTAL

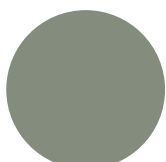

Ash

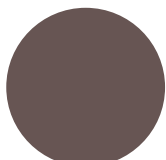

Clay

Iron  
MÉTAL

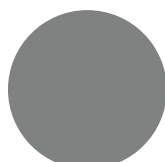

Inox

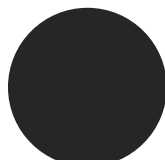

Black

Om  
BOIS



Oak



Wenge

Techno  
PMMA



Fluor

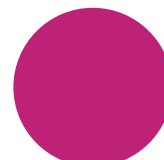

Fuxia



Ice

# SWOP P3 PRO PODO



## Dimensions

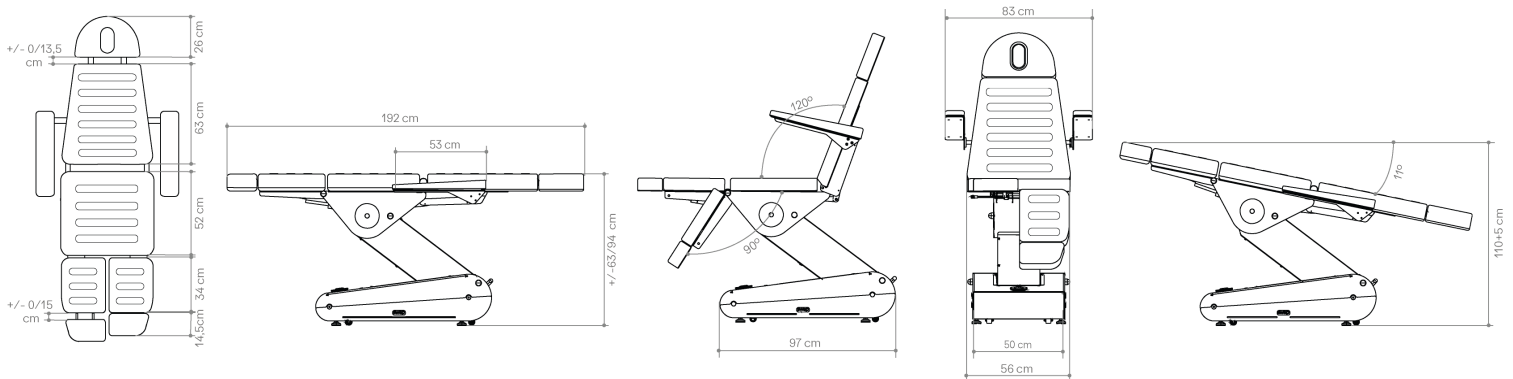

## Spécifications Générales

MOTEURS  
3 moteurs

DIMENSIONS (LONGUEUR X LARGEUR)  
192 x 83 cm

HAUTEUR (MIN. ET MAX.)  
63/94 cm

POIDS  
105 kg

ÉPAISSEUR  
10 cm

DENSITÉ  
40 kg/m<sup>3</sup>

CAPACITÉ DE CHARGE  
175 kg

FONCTIONNEMENT  
Télécommande à main  
(comprise)/Commande à  
pied (option)

ALIMENTATION  
230 V - 50/60 Hz

INTENSITÉ MAX.  
2 A

VÉRIN ÉLECTRIQUE  
6.000 N

GARANTIE  
2 ans sur la table et le revê-  
tement

MATELAS

Revêtement avec Naggura  
Skin : 100% composé de  
vinyle en blanc ou gris.

Résistance à l'abrasion :  
>250.000 cycles. Protection  
contre germes et rayons  
UV.