

Work happily



V1.3

naggura'swop

naggura.com

Our products

 Podo



The Swop P3 Pro Podo is a 3-engine podiatry bed of optimum stability and ultra-compact frame.

Wood, Metal or Pmma



Collections

Nordic
METAL

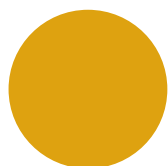

Yellow



Blue

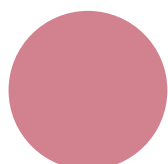

Pink

Foll
METAL

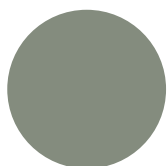

Ash

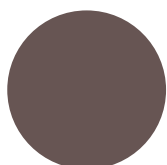

Clay

Iron
METAL

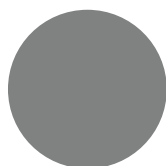

Inox

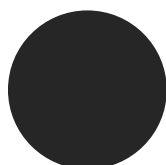

Black

Om
WOOD



Oak



Wenge

Techno
PMMA



Fluor

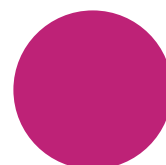

Fuxia



Ice

SWOP P3 PRO PODO



Dimensions

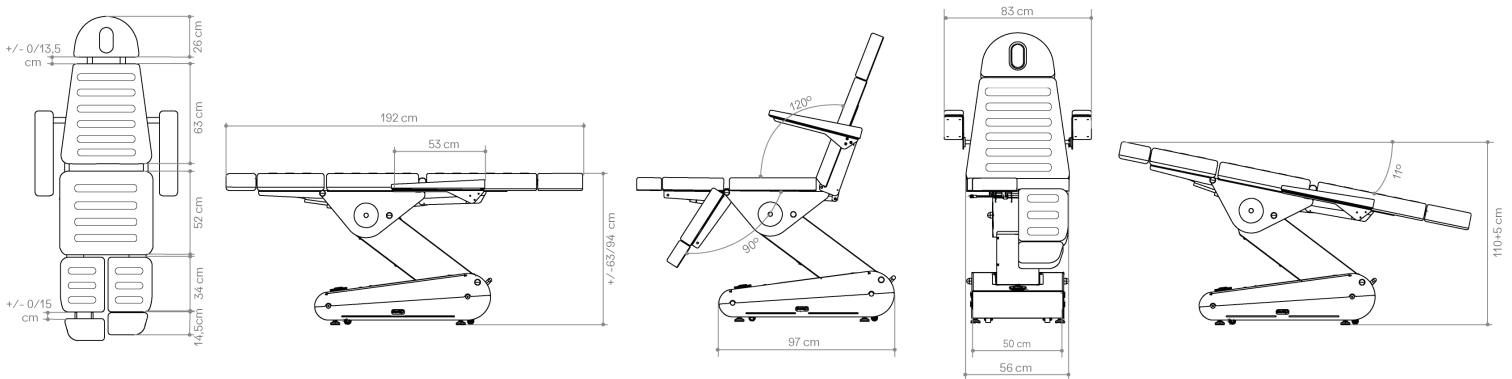

General Specifications

MOTORS
3 engines

DIMENSIONS (LENGTH X WIDTH)
192 x 83 cm

HEIGHT (MIN. AND MAX.)
63/94 cm

WEIGHT
105 kg

THICKNESS
10 cm

DENSITY
40 kg/m³

LIFTING CAPACITY
175 kg

OPERATION
Hand controller (included)/
Foot controller (optional)

POWER SUPPLY
230 V - 50/60 Hz

MAX. INTENSITY
2 A

ELECTRIC MOTOR
6.000 N

WARRANTY
2 years on table and
upholstery

CUSHION

Naggura Skin upholstery:
100% vinyl compound in
white or grey.

Superior abrasion resis-
tance: >250.000 cycles.
Protection against germs
and UV rays.